

Design and construction of double-Blumlein HV pulse power supply

DEEPAK K GUPTA and P I JOHN

Institute for Plasma Research, Bhat, Gandhinagar 382 428, India
e-mail: john@ipr.res.in

MS received 28 June 2000

Abstract. A double Blumlein pulse generator is constructed using a coaxial cable. This power supply is capable of providing a voltage up to 20 kV across a matched load and 40kV across an open load with a charging voltage of 10 kV. It is designed to provide a pulse width of 110ns. A rise time of ~ 10 ns is obtained with present spark gap. A rotating spark gap is also designed and constructed to get a pulse repetition rate of 25Hz. Although, in the present work this pulse generator is used to study the streamer discharge in air, it is useful in many other applications also.

Keywords. Pulse power supply; pulse forming line; Blumlein-spark gap; water load; streamer discharge.

1. Introduction

Short duration high voltage pulses, with fast rise time and a good flat top, are required for many gas discharge experiments and applications. A practical way of getting high voltage rectangular pulses of width less than one microsecond is with the help of a pulse-forming line (PFL). A PFL has the capability of providing a flat top rectangular pulse with fast rise time. A fast closing switch is necessary for achieving fast rise time and spark gap switches have turned out to be the most appropriate. A repetitive pulsed power supply can also be obtained by controlling the switching rate of the spark gap and the charging time of the PFL.

Here we present the design and fabrication of a pulse power supply in a double Blumlein configuration. Although, this power supply was made with the objective of studying the streamer corona discharge and fast breakdown processes in air, it can also be used as a trigger generator. The power supply is designed for a pulse width of 110ns. With a charging voltage of 10 kV, the present power supply is able to provide a voltage of 20 kV across a matched load and a maximum of 40 kV across an open load. A rise time of ~ 10 ns has been obtained with the present spark gap switch. A detailed description of spark gap and water load is presented here. The power supply is also used with a rotating spark gap to get high voltage repetitive pulses at a frequency of 25 Hz. A description of a rotating spark gap is also presented here.

2. Basic principle

As PFL is widely used in many applications, its principle is well-understood and available in literature (Olson 1976; Somerville *et al* 1990). It can be seen as a pulse forming network with distributed RC, instead of lumped. Generally coaxial or strip-line geometry is used to get this distributed RC network. Coaxial cable is used in the present and many other similar works (Somerville *et al* 1990) due to easiness in handling and fabrication of power supply.

A simple PFL generator is shown in figure 1a. The pulse width, T , is twice the time taken by electromagnetic wave to travel the length of coaxial line in dielectric medium, filled between the coaxial conductors. Mathematically, it can be defined as

$$T = 2\epsilon_r L^{1/2}/c,$$

where, c is the speed of light in vacuum, L is the length of line and ϵ_r is dielectric constant of the material filled between the coaxial conductors of line. If current limiting resistance, R_{lim} is much larger compared to the load impedance Z_L , then the output voltage is given by,

$$V_0 = Z_L V / (Z_L + Z_0),$$

where V is the charging voltage and Z_0 is the characteristic impedance of the coaxial line. An ideal output voltage pulse is also shown in figure 1a, when load impedance is matched to the characteristic impedance of coaxial line (i.e. $Z_L = Z_0$). Under nominal conditions the voltage output of these power supplies cannot exceed the charging voltage. Moreover, in many applications mismatching of load may not be acceptable due to

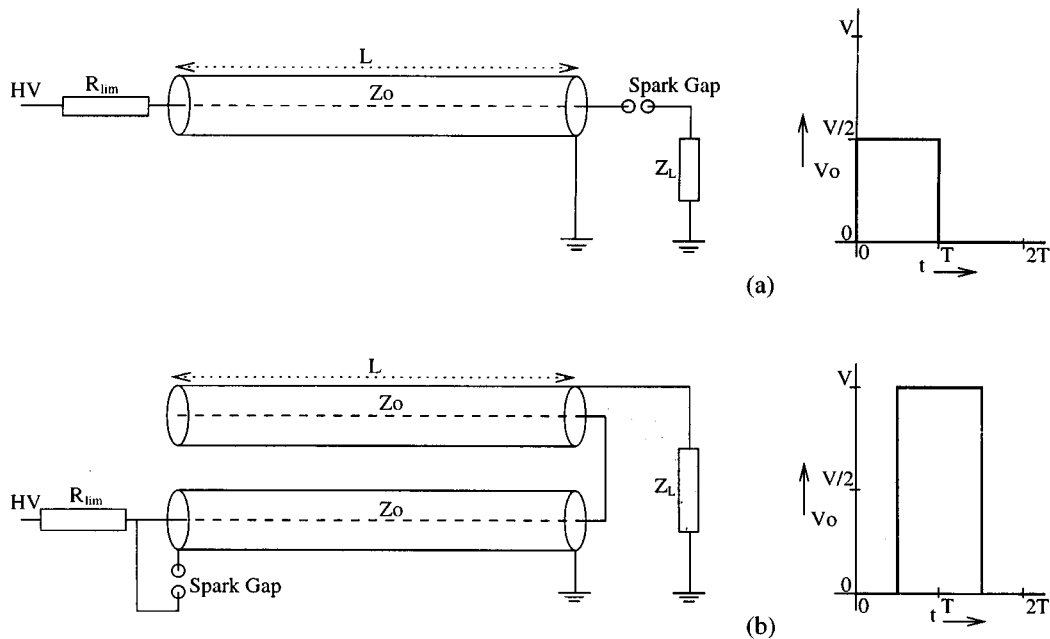

Figure 1. Schematics and output waveforms with matched load of (a) simple pulse forming line and (b) Blumlein.

appearance of HV reflections after the initial pulse. These two conditions put a major limitation on the simple PFL.

Enhancement of the output voltage can be achieved by using Blumlein instead of simple PFL. As it is clear from the schematic shown in figure 1b, two transmission lines are used in this configuration. The output voltage in Blumlein is given by

$$V_0 = 2V Z_L / (Z_L + 2Z_0).$$

The output voltage of a matched Blumlein is equal to the charging voltage. Figure 1b also shows an ideal pulse shape when $Z_L = 2Z_0$. The delay of $T/2$ in the output voltage is due to time taken by the negative voltage pulse to appear across the load. The maximum voltage possible to get in a Blumlein is twice the charging voltage, across an open load.

Practically, efficiency of the system reduces due to presence of secondary transmission line which exist, between the outer braid of one of the coaxial line and ground plate (Somerville *et al* 1990). This problem can be avoided either by using ferrite or by winding the cable inductively. In the case of coaxial cable Blumlein, the problems of flash over and corona also arise at the cable ends.

In the present work, we have used the double Blumlein configuration (figure 2). It is based on the principle of connecting the two Blumlein in series to provide twice the output voltage of a single Blumlein. This configuration is able to provide a maximum voltage output of $4V$ across an open load and $2V$ across a matched load ($Z_L = 4Z_0$). To obtain the maximum efficiency, the coaxial cables are wound inductively. Moreover, a double-Blumlein also eradicates the problems of flash over and corona from the cable ends.

3. Layout and construction

3.1 Double Blumlein

A double Blumlein generator is made using an RG213 coaxial cable. This coaxial cable has a characteristic impedance of 50Ω and can be safely charged upto 10 kV . Polyethylene is used as the inner insulation between the coaxial conductors of the cable. A total cable length of 40 m is used in three pieces, where one is of 20 m and other two are of 10 m each. Although we used three pieces of coaxial cable, due to non-availability of a continuous length of 40 m of cable, it is advisable to use a continuous cable for better pulse shape. From the continuous length of cable, the braid should be removed from two sections, which essentially creates three transmission lines. The minimum length of the braid removed is dependent upon the surface-flash-over length required for twice the operating voltage.

The schematic of the present power supply is shown in figure 2. When the spark gap switch is fired after charging the double Blumlein, an output voltage develops between the points D and B. Either point D or B can be connected to the ground in order to produce a negative or positive voltage at the other terminal. However the winding arrangement needed for maximising the efficiency is different for different polarities. For the present power supply, we have adopted an inverting double Blumlein arrangement (i.e. polarity of output voltage is opposite to the charging voltage) due to its better voltage efficiency (Somerville *et al* 1990). It is achieved by grounding the point B and obtaining the output from D. For winding the cable, a non-conducting former of diameter 20 cm is

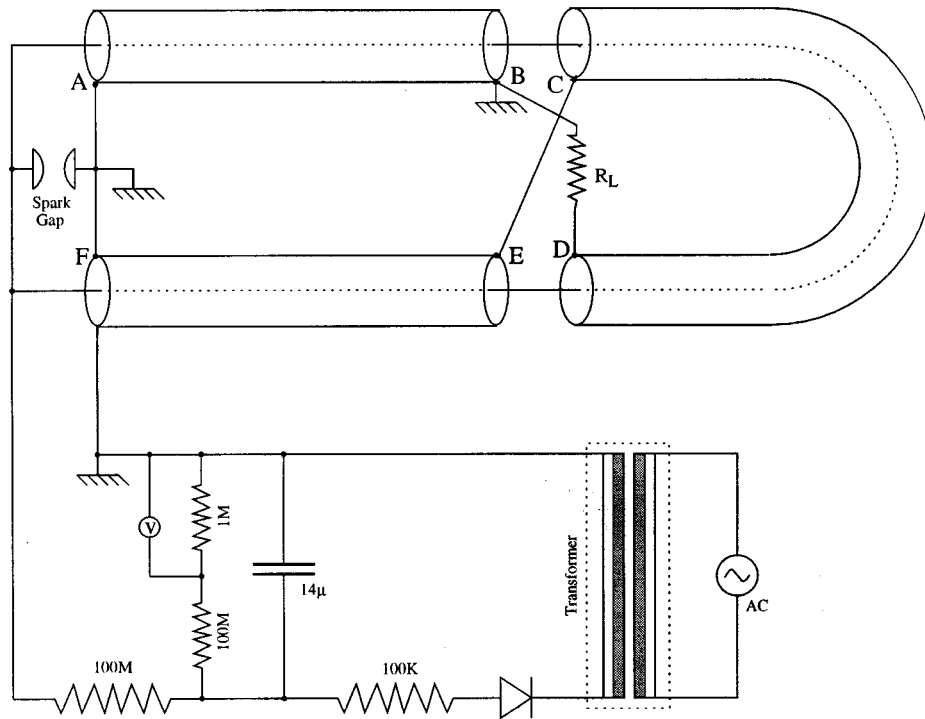

Figure 2. Schematic of constructed double-Blumlein pulse power supply.

selected because the use of a former of diameter at least ten times larger than that of the coaxial cable is recommended.

The winding arrangement and layout is shown in figure 3. Cable F-E is wound inductively, to decouple it from the ground and also produce high impedance for the secondary transmission line between cable F-E and the ground plane. Cable C-D is also wound inductively to increase the dipole antenna impedance, thereby reducing secondary transmission losses. By mutual inductive winding of cable C-D and F-E, this impedance is further increased. The layout of the cable A-B is not very important since it is grounded at both the ends, however, it is also wound on the former for compactness. A typical output voltage and current pulse, with matched load, is shown in figure 4.

3.2 Spark gap switch

A low cost and simple spark gap is built for use as a switch for the present double Blumlein pulsed power supply. A photograph of this spark gap is shown in figure 5. The hexagonal flat faces of two M8 SS nuts are aligned parallel to each other. Sharp points are avoided by smoothing out these faces and other sharp edges.

The spark gap is used in the self-triggered mode at atmospheric pressure in air. The gap between two flat electrodes can be easily adjusted for different charging voltages, with the screw type adjustment on the insulated mount. The current rise time of ~ 10 ns is measured using Pearson current transformer (No. 2878, usable risetime 5ns). The current

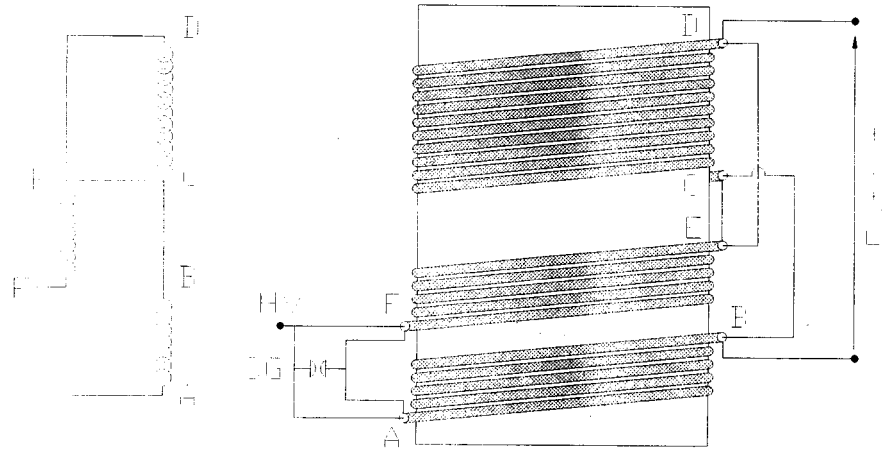

Figure 3. Winding arrangement and layout of double-Blumlein generator.

pulse shown in figure 4 is measured using current transformer having usable risetime 20ns (Pearson, No.411).

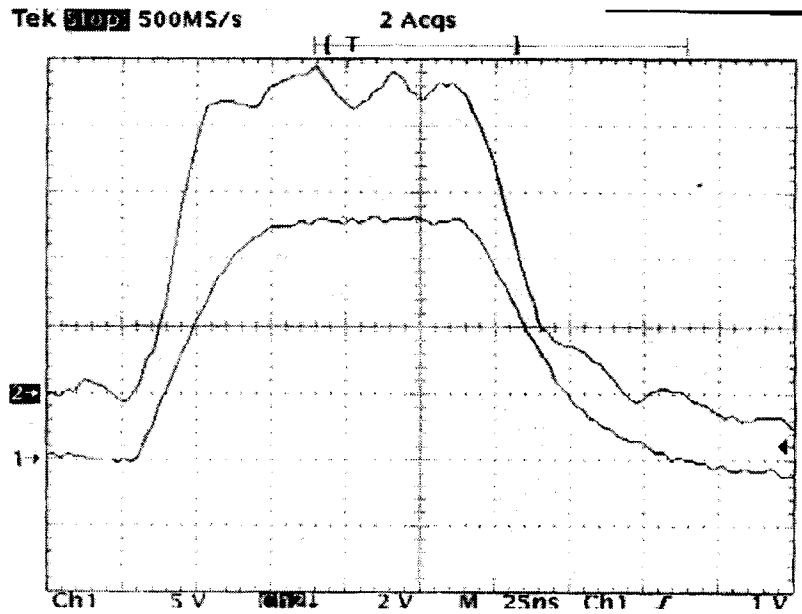

Figure 4. Output voltage (channel 1, bottom trace, 5kV/div; using Tektronix 75 MHz P6015A 1000X probe) and current pulse (channel 2, top trace, 20A/div; using Pearson current transformer no. 411). Time base; 25ns/div.

3.3 Rotating spark gap

A rotating spark gap is made by mounting the ground electrode on a rotating plane. The schematic view of a rotating spark gap is shown in figure 6. A concentric metallic ring is mounted on a vertically rotating, non-conducting, circular disk. Two similar spark gap electrodes are mounted inside this metallic ring. Both these electrodes face outward and are situated at the points diametrically opposite. The weights of both the electrodes and their locations from the centre of the disk are kept the same.

The mounted electrodes are both electrically connected to a circular ring. Electrical connection to this rotating ring is made by touching two flat metallic strips to it. One end each of both the contact strips is connected to a fixed horizontal grounded plate.

The HV electrode of the spark gap is mounted on a fixed insulator, placed in front of the rotating disk. The location of the HV electrode is adjusted in such a way that as the disk rotates each grounded electrode comes close to the HV electrode once. When either of the electrodes reaches near the HV electrode, a sufficient voltage applied between the two causes self-breakdown.

In the present experiment, a motor with the fixed speed of ~ 25 rotations per second is used. The breakdown gap between only one rotating grounded electrode and the fixed HV electrode is kept at a minimum. Hence only one spark gap gets triggered in each rotation, which gives the repetition frequency of ~ 25 Hz. As the time scale of repetition rate and pulse width differs by an order of five, rectangular voltage pulses are seen as voltage spikes in the peak detection mode of a digital storage oscilloscope (Tektronix TDS320). A typical oscillograph of current and voltage pulse is shown in figure 7.

3.4 Water load

For the present double-Blumlein generator, a purely resistive load of $200\Omega (= 4Z_0)$ is required for a matched condition. A water load using ordinary tap water and an adjustable

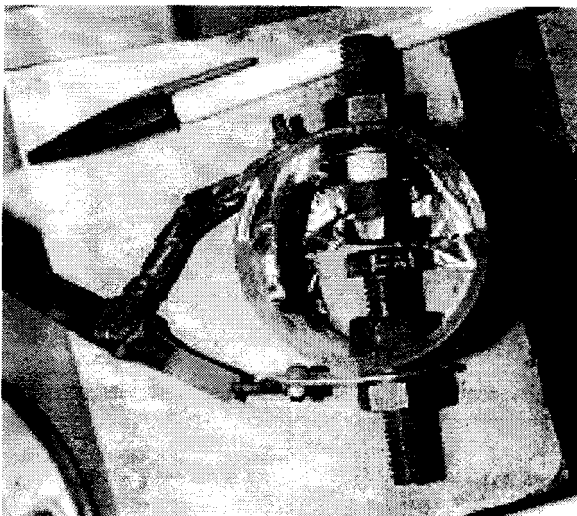

Figure 5. Spark gap switch.

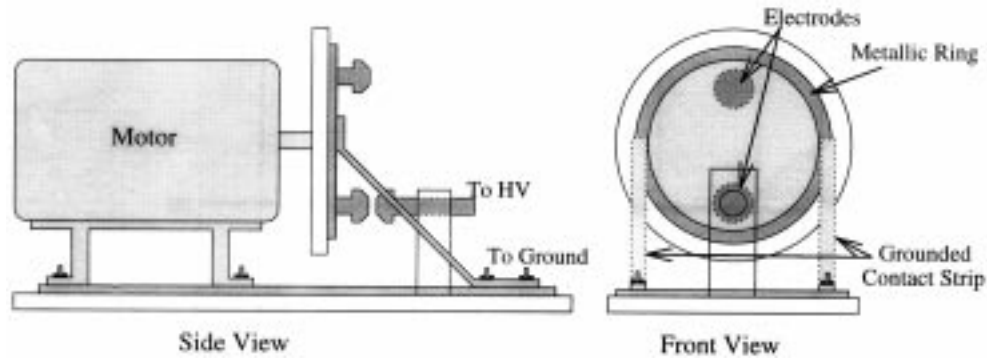

Figure 6. Schematic view of rotating spark gap switch.

electrode is designed and fabricated for this requirement. A schematic of this water load is shown in figure 8. A metallic cylinder is used as the ground electrode and to store the tap water. A nut is used as the HV electrode and this is dipped in water from a central hole made in the perspex top cover of the cylinder. This nut passes through a proper bolt fixed on the central hole of the perspex top. Using this nut-bolt arrangement, dipped length of HV electrode in the water can be adjusted which controls the effective resistance of the tap water load. The pulses shown in figures 4 and 7 are measured across this water load under matched conditions.

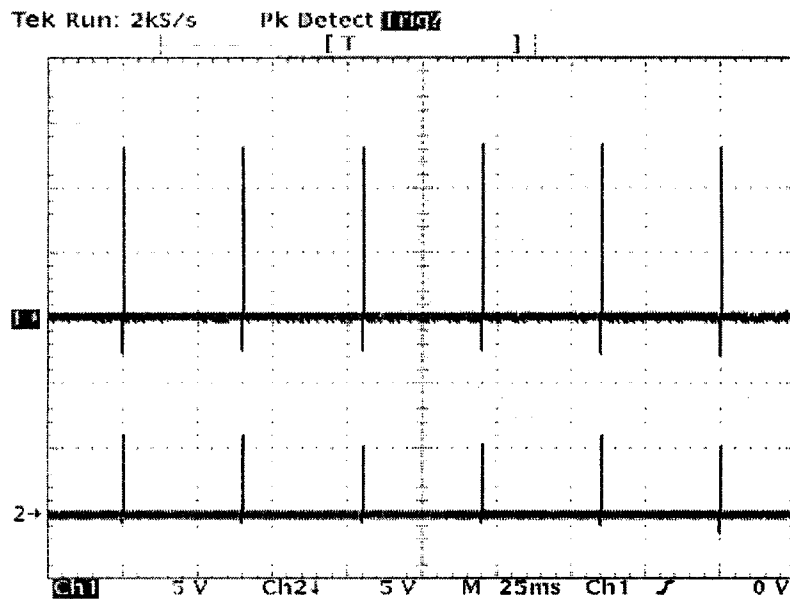

Figure 7. Oscillograph of voltage (channel 1, top trace) and current (channel 2, bottom trace) output of double-Blumlein generator with rotating spark gap.

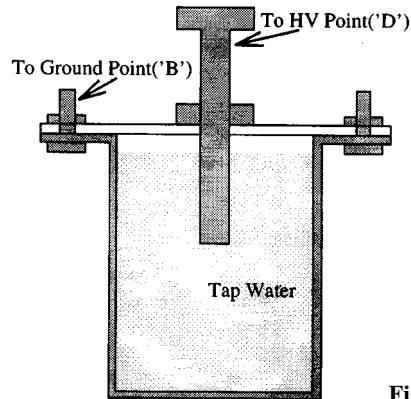

Figure 8. Schematic of tap water load.

4. Application and discussion

The present pulse generator is used to produce the streamer corona discharge with point-plane geometry in air at atmospheric pressure. Discharge electrodes with a current measuring resistance, R_m , are connected in parallel to the water load as shown in figure 9a. No modification of the applied pulse is observed in the presence of streamer discharge which is desirable for such applications.

Due to the capacitance of the point-plane gap with R_m , the circuit acts as a high pass filter or differentiator circuit, in the absence of discharge. A typical differentiated signal, across $R_m = 500\Omega$, is shown in figure 9b. Figure 9c shows a streamer current with differentiated rectangular applied pulse signal across $R_m = 500\Omega$ when the streamer occurs. A similar signal is shown in figure 9d when R_m is kept at 47Ω to reduce the contribution of the differentiated rectangular pulse signal.

Total charge of $\sim 10^{10} - 10^{11}\text{C}$ is estimated by integrating the streamer current pulse. Considering a discharge volume of $\sim 10^{-4}\text{cm}^3$, the estimated plasma electron density is $\sim 10^{14} - 10^{15}\text{cm}^{-3}$. Order of this density is same as expected in the case of streamer discharge (Meek & Craggs 1953).

In figures 9c and d, the time delay of $\sim 100\text{ns}$ can be clearly seen between the rising edge of applied voltage and the appearance of discharge current. This corresponds to the formative time lag of the streamer discharge. The contribution of the statistical time lag in observed delay is negligible which has been checked by providing enough seed electrons and by exposing the gap with UV light. The estimation of formative time lag (Meek & Craggs 1953) can be done by using the formula $t_f = \ln(n/n_0)/\alpha v_d$, where α is the Townsend ionization coefficient ($\sim 14.5\text{cm}^{-1}$) and v_d ($\sim 1.7 \times 10^7\text{cms}^{-1}$) is the drift velocity of electrons, for air at $E/p = 40\text{Vcm}^{-1}\text{Torr}^{-1}$ (Raizer 1997), n_0 is the initial electrons (~ 1) and n is the electrons ($\sim 10^{10}$) after formative time lag, t_f . The time lag estimated using this method is $\sim 93 \times 10^{-9}\text{s}$ which is near to the observed time lag.

The advantage of the double-Blumlein generator, other than its low cost, compactness and simple construction, is its ability to provide an output voltage that is 2 to 4 times the charging voltage. To produce further high voltages, without increasing the charging voltage, inverting and non-inverting generators can be set in series (Somerville *et al* 1990). The disadvantage of this arrangement is that the output impedance of the system

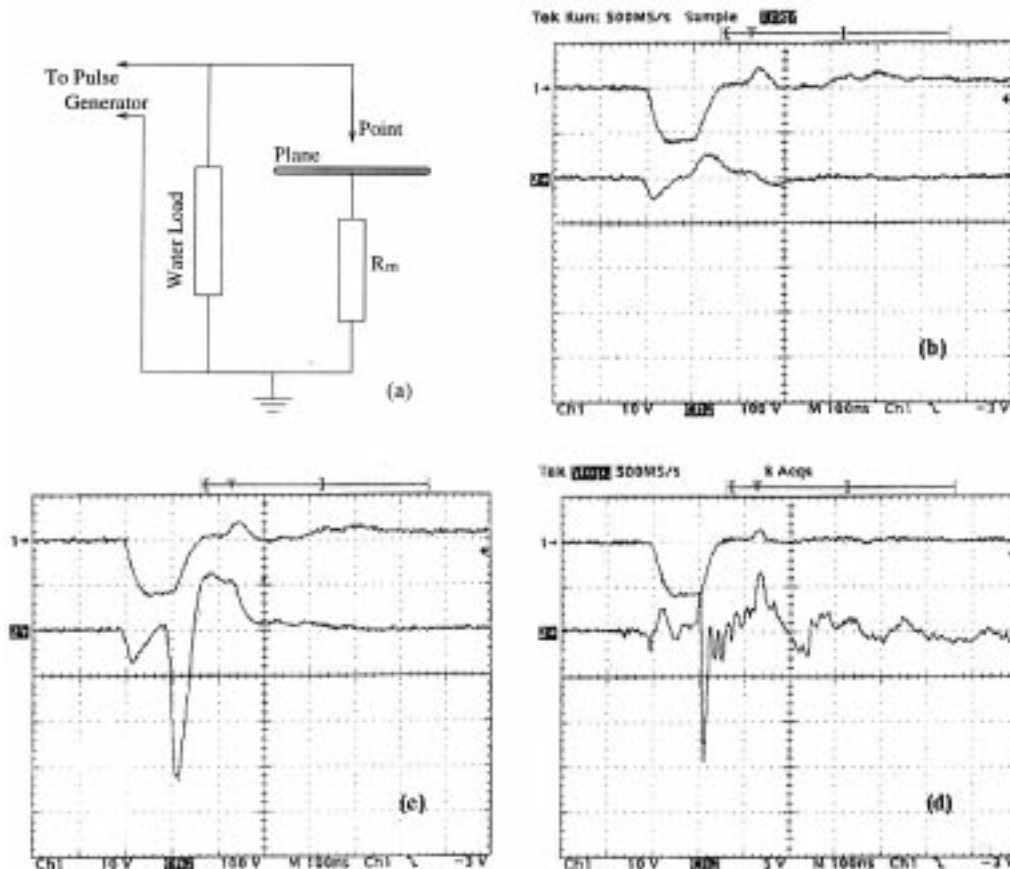

Figure 9. (a) Circuit diagram for streamer discharge. (b) Ch2: Signal across $R_m = 500\Omega$ without discharge, 100V/div.; Ch1: Applied voltage pulse, 10kV/div. (c) Ch2: Signal across $R_m = 500\Omega$ with discharge, 100V/div.; Ch1: Applied voltage pulse, 10kV/div. (d) Ch2: Signal across $R_m = 47\Omega$ with discharge, 5V/div.; Ch1: Applied voltage pulse, 10kV/div.; Time scale in (b)-(d) is 100ns/div.

becomes high which limits the driving capacity of the circuit. Although present power supply is used for the study of streamer discharge, it can very well be used for many other experimental studies. Also this, or a similar power supply, is best suited for the trigger generator where load capacity is small.

Pulse rise time can be shortened by using a better designed spark gap switch. Although extra care was taken in making the connections to minimize the stray inductance, the measured rise time is still a few nanoseconds greater with the rotating spark gap, when compared to a fixed spark gap. For efficient charging of the PFL, when working with the rotating spark gap, the charging resistance, R_{lim} , should be optimized to fully charge the generator in between two consecutive pulses. A charging resistance value of $1M\Omega$ is chosen in the present case which corresponds to a charging RC time constant of 4 ms, which is 10 times faster compared to the repetition rate of the pulse.

To avoid mechanical instability and wobbling of the rotating disk at faster speeds, electrodes should be situated diametrically opposite to each other on the disk. Moreover the product of mass and distance of electrode from the centre of each electrode should

be approximately the same. Problems of mechanical instability and wobbling can also be overcome by choosing a rotating disk which is heavier compared to the electrodes. This, however, requires a rotating motor with higher driving capacity.

5. Conclusions

We have presented here the design and construction of a coaxial double-Blumlein high voltage pulse generator with sufficiently fast rise time and good voltage gain. The generator is of very low cost, and is compact and easy to make. It has been used to study the streamer discharge and can also be used for many other applications (e.g., trigger generator). Power supply with the presented rotating spark gap will be useful for the application of streamer discharge for gaseous pollutant treatment (Penetrante & Schultheis 1993).

We wish to thank Dr S V Kulkarni for helping us to understand corona discharge and for setting up the experiment to study streamers.

References

- Meek J, Craggs J 1953 *Electrical breakdown of gases* (Oxford: Clarendon)
- Olson N 1976 The power behind the pulse. *Optical Spectra*
- Penetrante B, Schultheis S 1993 *Non-thermal plasma techniques for pollution control; Parts A & B*. NATO ASI (Spring-Verlag)
- Raizer Y 1997 *Gas discharge physics* (Springer)
- Somerville I, MacGregor S, Farish O 1990 An efficient stacked-Blumlein HV pulse generator. *Meas. Sci. Technol.* 1: 865–868