



Fascinating Organic Transformations

2. The Ubiquitous Hydrogen Bond

Subramania Ranganathan

Hydrogen bonds can transform simple molecules into beautiful architectures. This is well illustrated in this article.

Organic transformations are generally assumed to involve reactions in which covalent bonds are made, broken or rearranged. We can think of a wider connotation for the term 'transformation' if we include changes brought about by non-covalent forces. Although such interactions are weaker, the transformations can be quite dramatic, in terms of resulting structures and properties. In this article, let us consider the most important non-covalent interaction, viz., the hydrogen bond and the wide variety of ways in which this bond can lead to almost magical transformations of even simple organic molecules.

Definition of a Hydrogen Bond

A hydrogen atom bonded to an electronegative atom like oxygen or nitrogen has a small positive charge, due to bond polarization. It can therefore have an attractive interaction with any electron rich group in the vicinity. Usually, electronegative atoms have residual lone pairs available for such interaction. Hence, a fragment such as X-H ... Y, in which both X and Y are electronegative atoms has a stabilizing interaction. This weak force is called the hydrogen bond.

Electrostatic interactions are quite common in molecules with uneven charge distributions. The importance given to hydrogen bonds is due to several reasons. Hydrogen bonds are ubiquitous and easily recognisable. Importantly, the interaction has sufficient directional character for it to be classified as a 'bond'. The X-H unit prefers to be collinear with the electron pair on Y. But some flexibility is allowed, since the interaction is not quite strong (especially compared to covalent bonds). The directionality of hydrogen bonding is



After nearly a three-decade long innings as an inspiring teacher and researcher at IIT Kanpur, S Ranganathan is now at RRL, Trivandrum. He and his chemist wife, Darshan, plan to set up (without government assistance) "Vidyanantha Education Centre", to promote education, art and culture.

Keywords

Hydrogen bond, water structure, self assembly.

Hydrogen bonds are ubiquitous, easily recognisable and have sufficient directional character.



The directionality of hydrogen bonding is responsible for creating beautiful structural frameworks from simple building blocks.

responsible for creating beautiful structural frameworks from simple building blocks. It is possible to create chains, sheets, helices, three-dimensional networks, etc., using hydrogen bonds as the principal glue. The resultant shapes are not merely aesthetically pleasing but the transformed molecules become endowed with remarkable properties as a result of hydrogen bonding.

The importance of the hydrogen bond was stated clearly and forcefully as early as in 1939 by Linus Pauling in the first edition of his celebrated book *The Nature of the Chemical Bond*:

“Although the hydrogen bond is not a strong bond (its bond energy, that is, being in most cases in the range 2 to 10 kcal/mol) the energy of the reaction $X-H+Y \rightarrow XH \cdots Y$, it has great significance in determining the properties of substances. Because of its small bond energy and the small activation energy involved in its transformation and rupture, the hydrogen bond is especially suited to play a part in reactions occurring at normal temperatures. It has been recognized that hydrogen bonds restrain protein molecules to their native configurations, and I believe that as the methods of structural chemistry are further applied to physiological problems, it will be found that the significance of the hydrogen bond for physiology is greater than that of any other single structural feature”.

Seldom in science has any statement been so prophetic. In the intervening five and a half decades, the mural that encompasses the domain of hydrogen bonds has covered a wide area. Even a reasonable coverage of the theme in these pages would be difficult. Faced with this predicament, only a few representative examples are provided to highlight the art and science in hydrogen bonding networks.

Hydrogen Bonding in Water

As the most abundant liquid on the earth's surface, water is vital for the support of life. Even though the molecular formula of water is H_2O , it does not exhibit properties which you would expect from comparison with H_2S (or with NH_3)! Strong hydrogen bonding in

Strong hydrogen bonding in water increases the density, the melting and boiling points, and lowers the acidity. It is also primarily responsible for the well-known fact that water and oil do not mix.



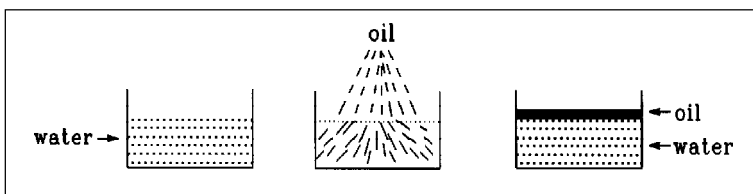
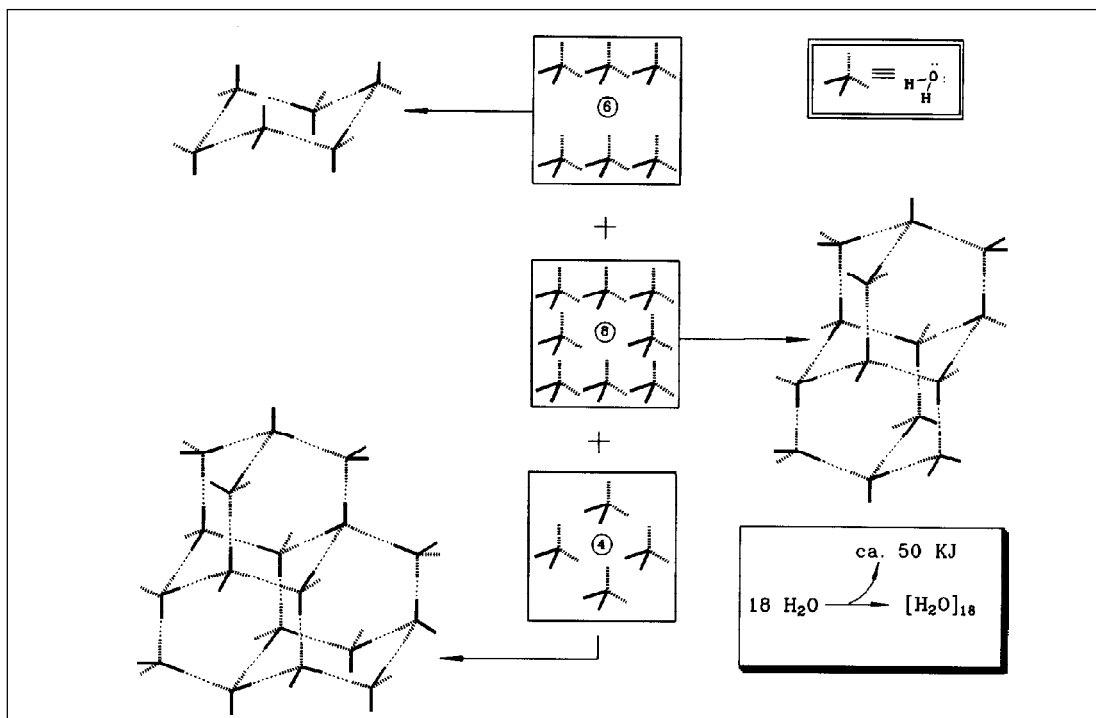

Figure 1. A dispersion of oil in water quickly gets 'oiled out'.

water increases the density, the melting and boiling points, and lowers the acidity as proton transfer interferes with the hydrogen bonded network. Hydrogen bonding in water is also primarily responsible for the well known fact that water and oil do not mix. The 'oiling-out' effect is schematically shown in *Figure 1*.

We showed how diamondoids can be made using wandering sigma bonds in a previous article (*Resonance*, Vol. 1, No. 1, 1996). It may come as a surprise that water can form similar structures entirely through hydrogen bonds. The water molecule has two donor sites (the O-H bonds), and two acceptor sites (the lone pairs on the O atom). This creates a perfect setup for a self-assembly to diamondoid structures, which is conceptually presented in *Figure 2*. It can be

Figure 2. Assembly of water molecules in diamondoids.



estimated that the transformation of 18 g of H_2O to 18 g of *water* can give rise to ca. 50 kJ stabilization. Such high stabilization to weight ratio cannot be matched through other non-covalent interactions.

The existence of carboxylic acids as dimers, even in the gas phase, is also because of strong hydrogen bonding. Hydrogen bonding can also significantly affect chemical reactivities (one example is found elsewhere in this issue!).

Hydrogen Bonding in Biological Systems

Life in simple terms represents a symbiosis of the functional systems (enzymes, proteins) and the information system (DNA, RNA) driven by regulated external energy inputs. It is interesting to see that one of the main structural motifs of proteins and enzymes, the α -helix, is stabilized by intrachain hydrogen-bonds which are *parallel* to the helix axis (Figure 3), whereas, the double-helical structure of DNA has the base-pairing hydrogen bonds *perpendicular* to the helix axis (Figure 4). It is pertinent to mention here that in proteins there

Figure 3 (left). An α -helix. Note the N-H \cdots O hydrogen bonds parallel to the helix axis.

Figure 4 (right). Double helix of DNA: here, P means phosphate diester, S means deoxyribose, the A-T double bond is the adenine-thymine pairing and the G-C triple bond is the guanine-cytosine pairing.

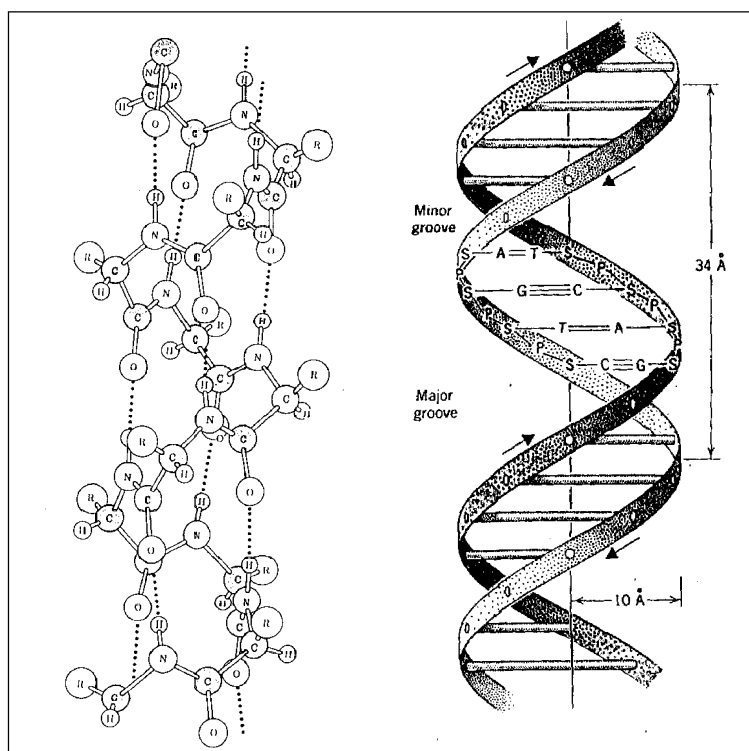

is another distinct sheet like structural element (a β -sheet) which is also produced by hydrogen-bonding between extended chains of polypeptides.

Hydrogen Bonding in Biomimetic¹ Systems

The Watson-Crick DNA duplex highlighted the importance of the specificity of hydrogen bonding between the base pairs Adenine (A) and Thymine (T), and Guanine (G) and Cytosine (C), (shown in *Figure 5*) in determining the properties of DNA. The proposal stimulated interest in creating other sets of molecules which bind specifically to each other, leading to the birth of a new discipline called 'Molecular Recognition'.

Of the thousands of examples available in this area, the most imaginative perhaps is the molecular replication model invented by Rebek. Avoiding the molecular complexity involved, the principle can be best understood by a model for replication shown in *Figure 6*. A template, drawn as a hacksaw, is shown on the left of this figure. It carries complementary hydrogen bonding sites for two molecular pieces. As a result of hydrogen bonding, the two partners are ideally aligned so that they can react to form a covalent bond. Breaking of the hydrogen bonds with the template would release the daughter molecule and let the template carry on the catalysis. In the extreme example in which the template and the daughter are the same, the molecules effectively self-replicate.

Hydrogen Bonding and New Materials

The planned growth of hydrogen bonds in two dimensions can lead to materials with interesting shapes. The first example shown in

It is interesting to note that one of the main structural motifs of proteins and enzymes, the α -helix, is stabilized by intrachain hydrogen-bonds

¹ The word 'biomimetic', coined by Ronald Breslow, essentially means imitating (or mimicking) a biological process (or a key part of it) using simple organic and/or inorganic molecules and complexes.

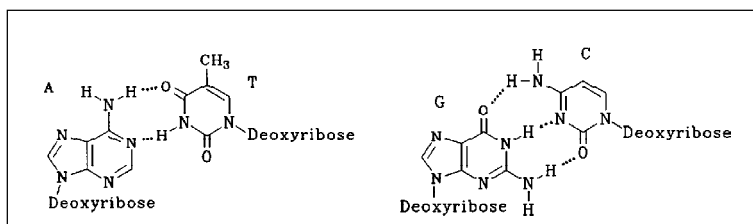

Figure 5. Hydrogen-bond directed mutual recognition of Adenine-Thymine (left) and Guanine-Cytosine (right).



Figure 6. Model showing catalysis of a reaction by a template which holds reacting partners through H-bonds.

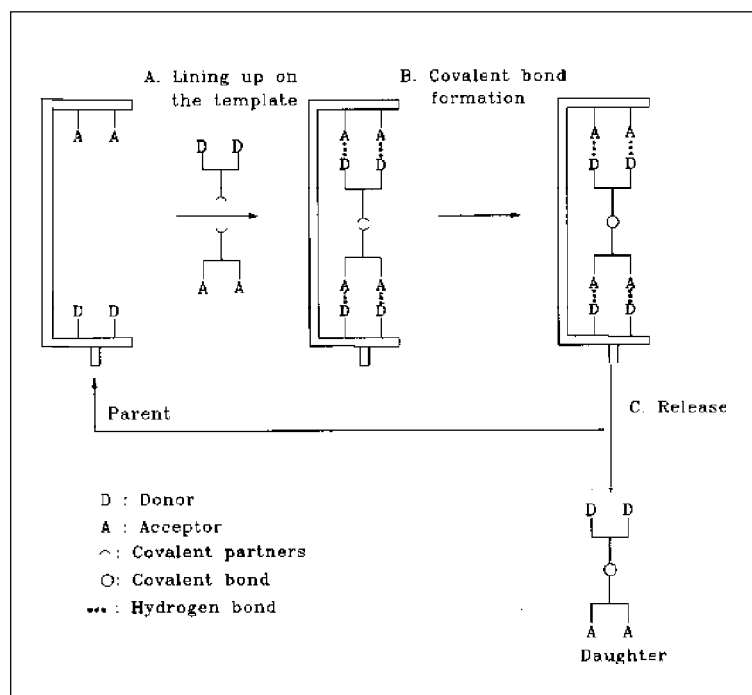

Figure 7 corresponds to a collection of identical molecules held together by hydrogen bonds. The strategic location of the interaction sites allows the formation of a two-dimensional sheet. Additional interactions between the benzene rings on adjacent sheets (through a different type of non-covalent interaction) result in a stack. Overall, a porous structure with interlocking columns is obtained.

Another example of a sheet-like structure resulting from hydrogen bonds is given in *Figure 8*. Here two different molecules, cyanuric acid and melamine, with complementary hydrogen bonding sites arrange themselves in a beautiful architecture.

In *Figure 3*, the α -helix is characterised by a sequence of parallel hydrogen bonds within the molecule along the helix axis. Other variations are possible, e.g., by mixing parallel and antiparallel arrangements of hydrogen bonds. A lovely example of a structure resulting from intermolecular hydrogen bonding with this type of directional character is shown in *Figure 9*. The tubular assembly has been demonstrated by X-ray crystallography. Such peptide-based

Hydrogen bonds in the hands of a practical dreamer can open up infinite possibilities.



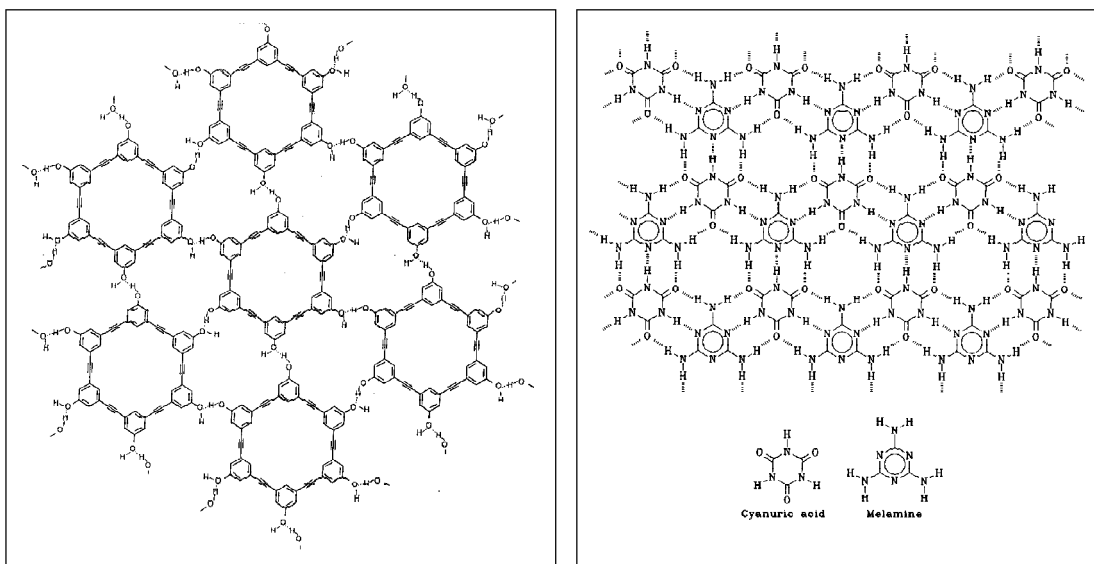

nanotubes can transport small molecular or ionic fragments, such as water, ammonia and proton. Hydrogen-bonding directed recognition has also been utilized to design new types of liquid crystalline materials by Lehn.

Figure 7 (top left). Rigid 'washers' held together by hydrogen bonds in a two-dimensional sheet.

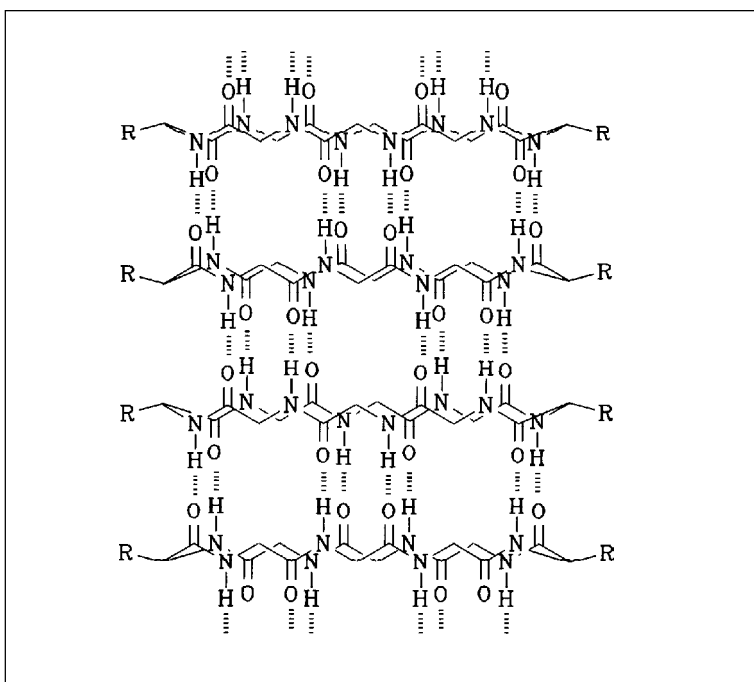

Figure 8 (top right). A beautiful 2D array of H-bonds produced from two components.

Figure 9. A tubular assembly through H-bond.

Hydrogen bonding has transformed mundane molecules to potential information storage systems, sieves, catalysts, etc.

Hydrogen Bonding, the Magical Glue

Hydrogen bonds in the hands of a practical dreamer can open up infinite possibilities. During the past few decades chemists have concentrated on the art of making and breaking very high energy (200–400 kJ/mol) covalent bonds. The edifices built and broken here are as made from concrete! In the present decade, chemists increasingly prefer to have more flexibility. Hydrogen bonding has proved to be very useful in this approach. The ubiquitous glue has transformed mundane molecules to potential information storage systems, molecular switches of all kinds, materials, surfaces, cavities, sieves, catalysts and on and on.

Address for Correspondence
S Ranganathan
Senior Scientist (INSA)
Biomolecular Research Unit
Regional Research Laboratory
Thiruvananthapuram
695 019, India.



The Busy Biochemist ... Otto Warburg was one of the great biochemists of the early part of the twentieth century (H A Krebs was one of his many students who won a Nobel Prize). Once he was invited to a ceremonial function to receive an award from the German Government. Warburg asked for the decoration to be sent by mail, for his experiments did not allow him time to leave the laboratory!

